

HOW MANY?

Name: _____

Date: _____

Instruction: Count the objects and write the correct number inside the small box.

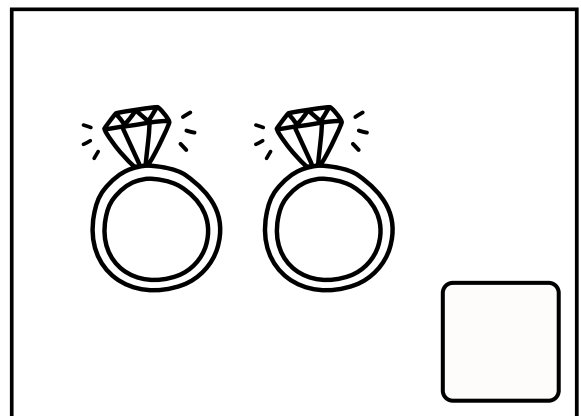
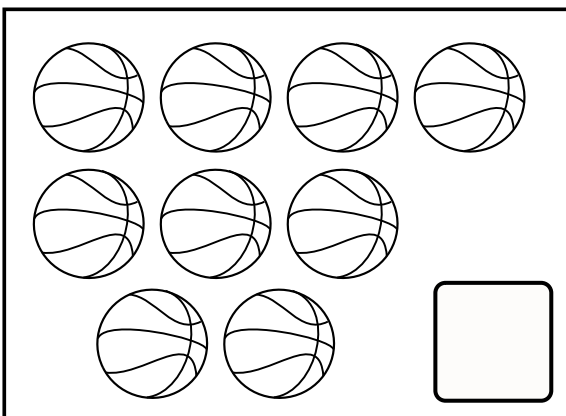
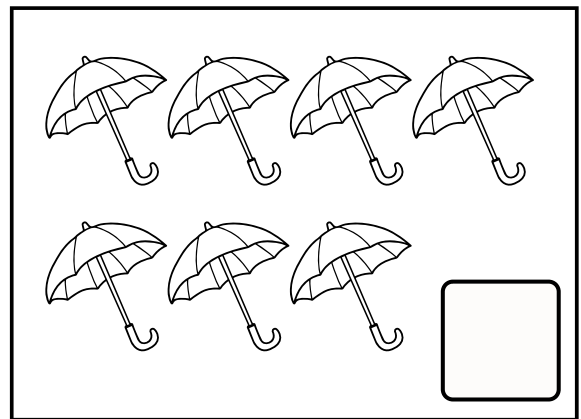
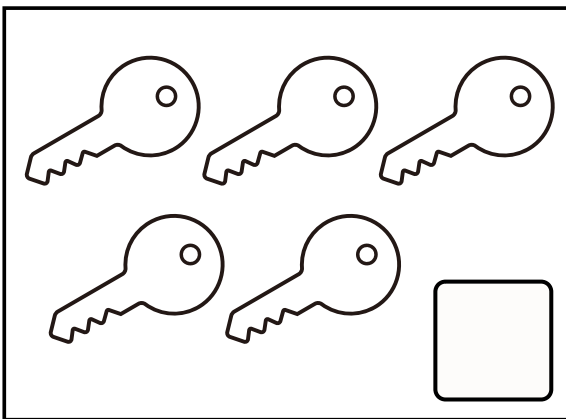
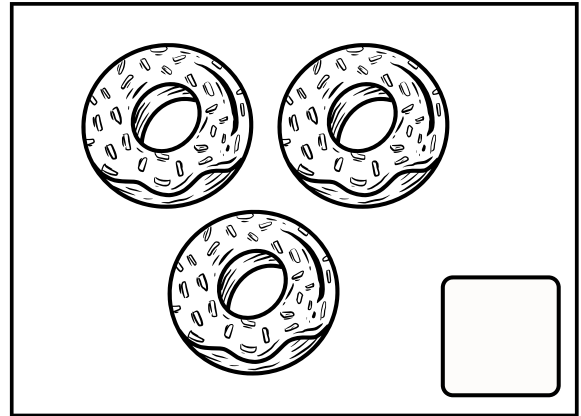
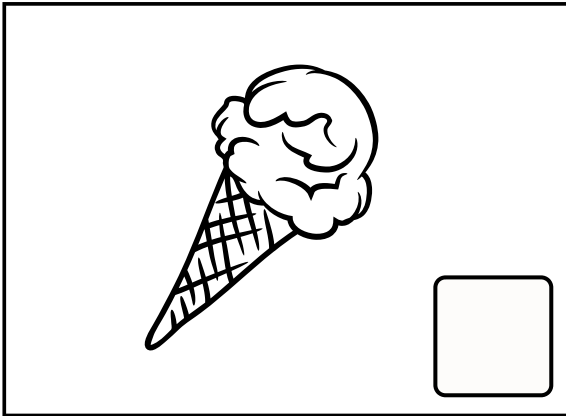

HOW MANY?

Name: _____

Date: _____

Instruction: Count the objects and write the correct number inside the small box.

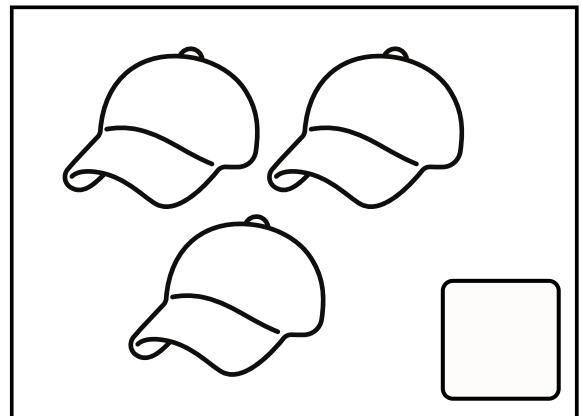
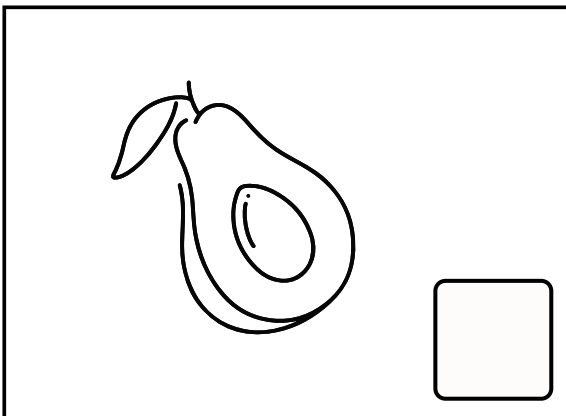
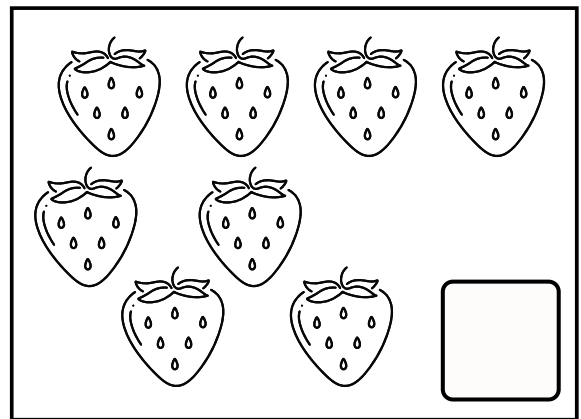
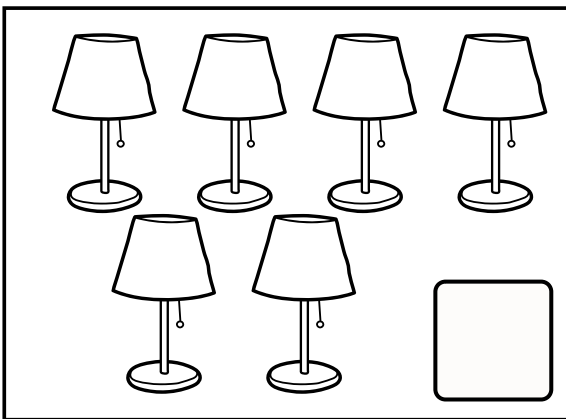
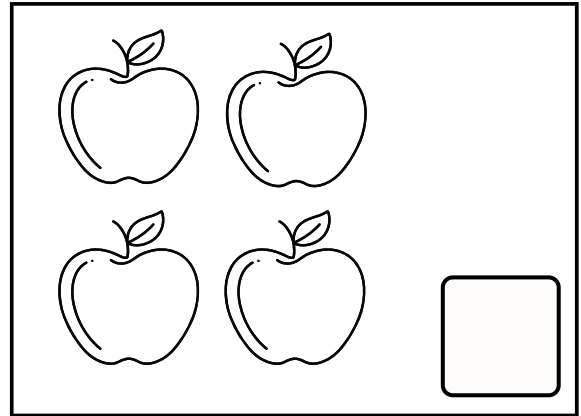
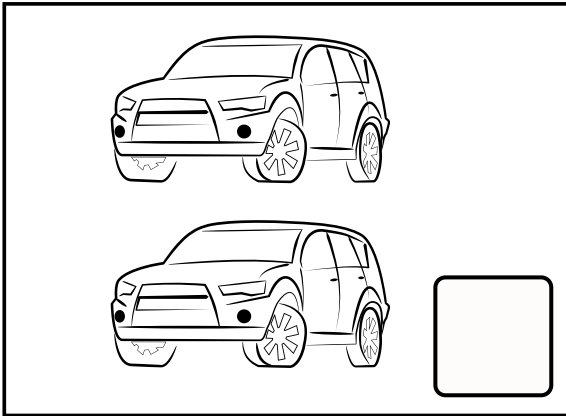

HOW MANY?

Name:

Date:

Instruction: Count the objects and write the correct number inside the small box.

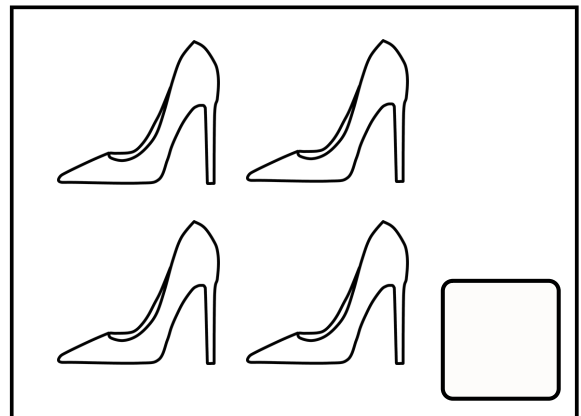
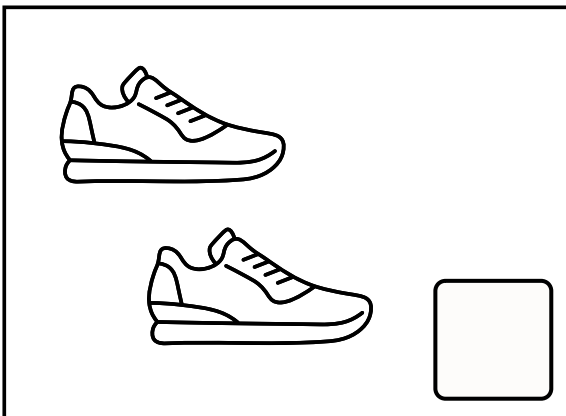
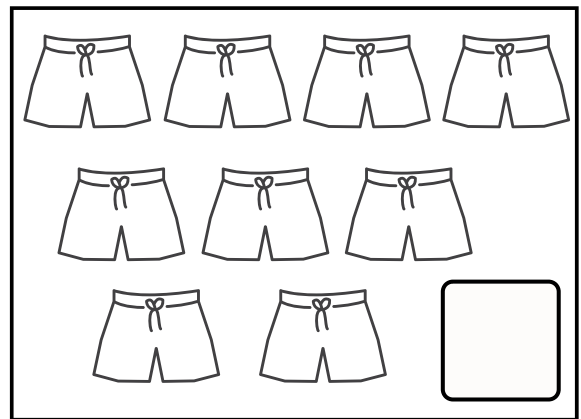
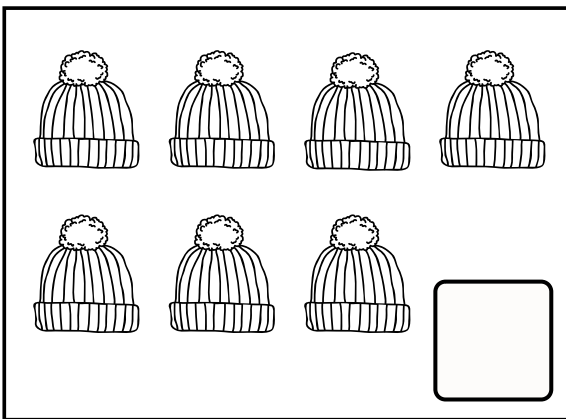
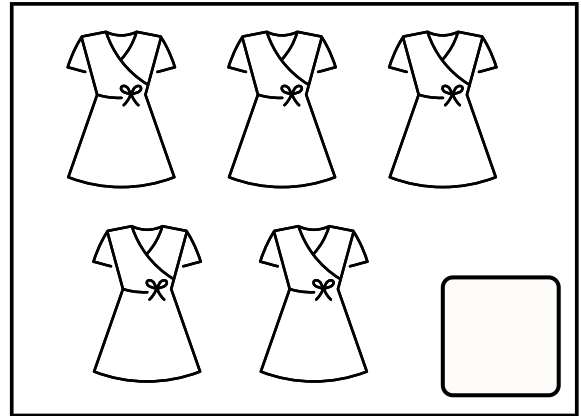
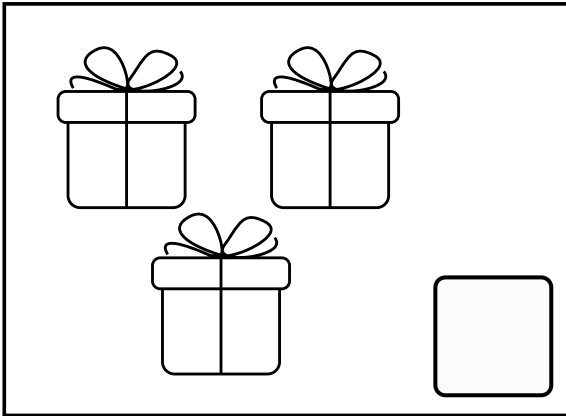

HOW MANY?

Name: _____

Date: _____

Instruction: Count the objects and write the correct number inside the small box.

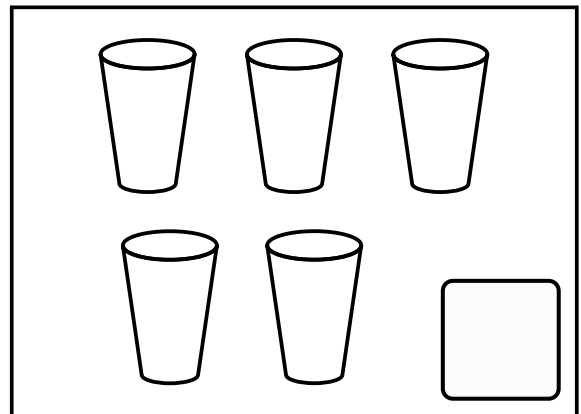
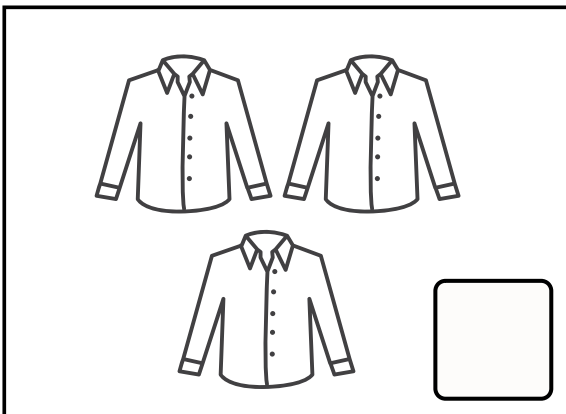
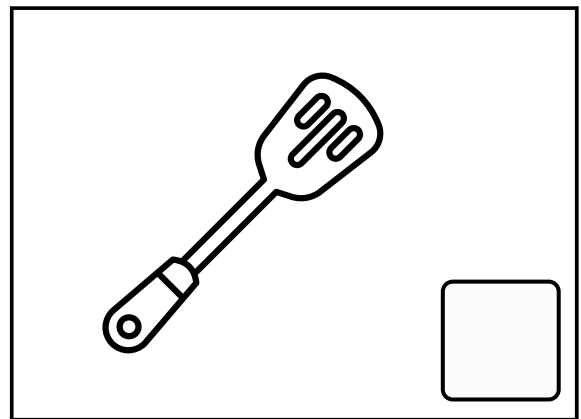
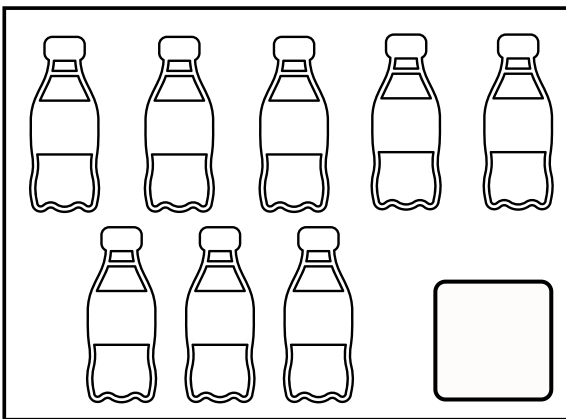
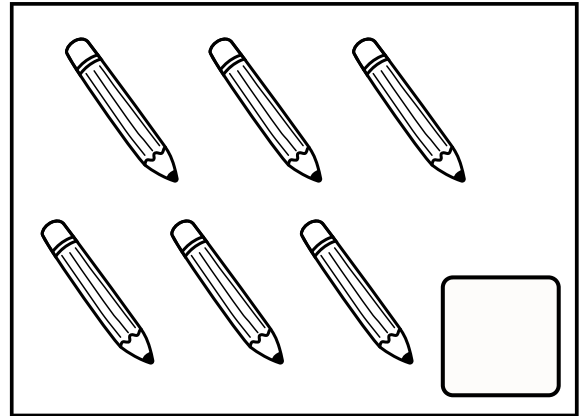
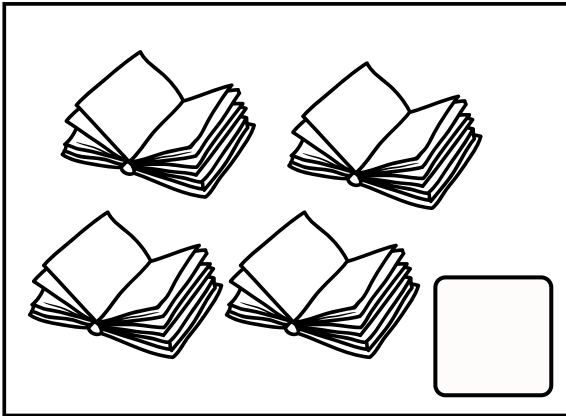

HOW MANY?

Name: _____

Date: _____

Instruction: Count the objects and write the correct number inside the small box.

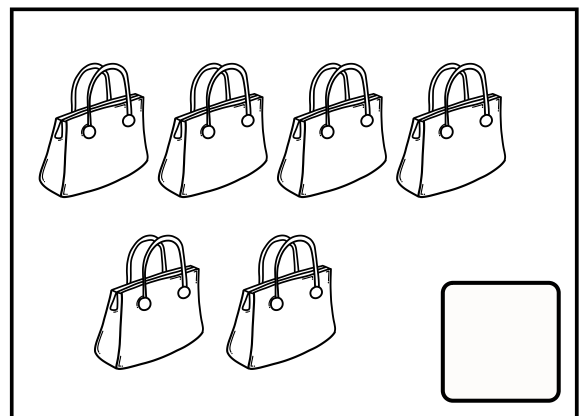
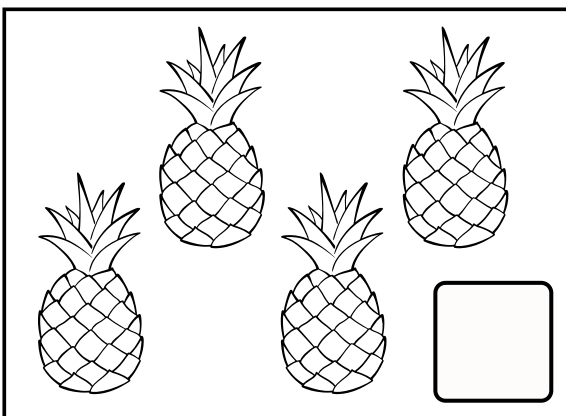
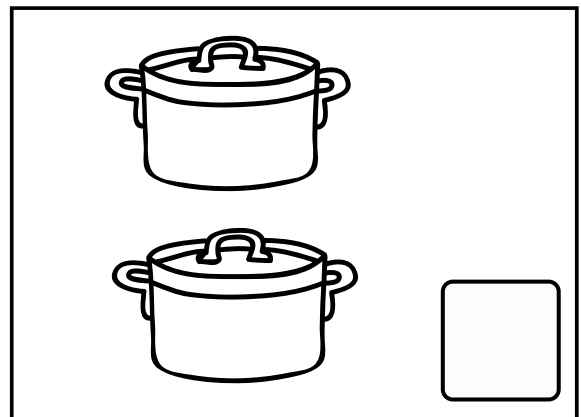
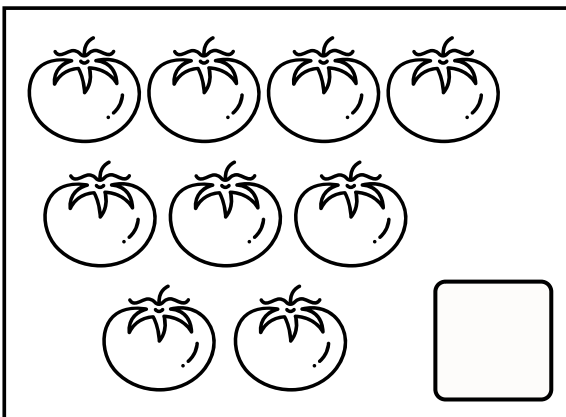
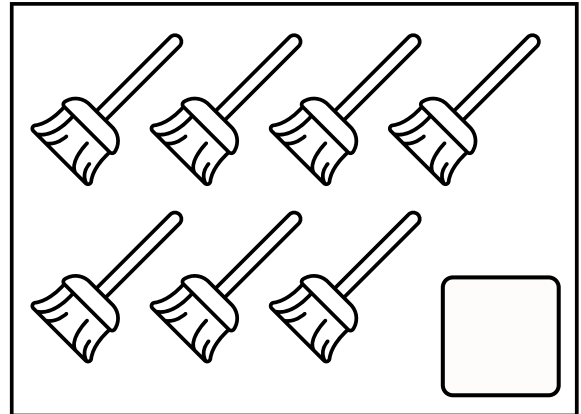
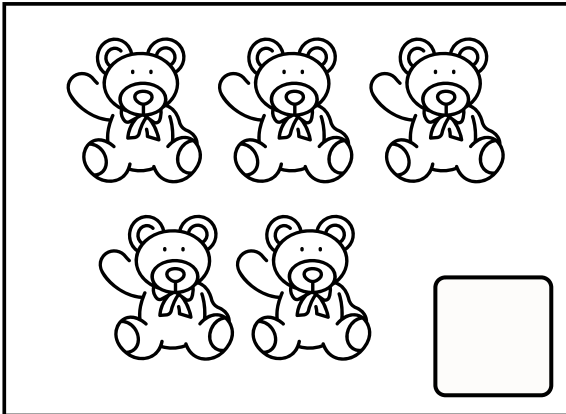

HOW MANY?

Name: _____

Date: _____

Instruction: Count the objects and colour the correct number.

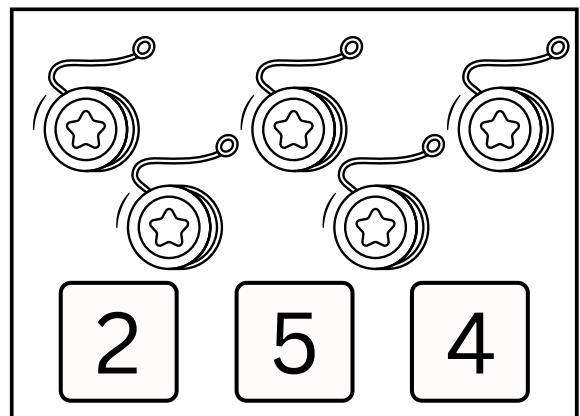
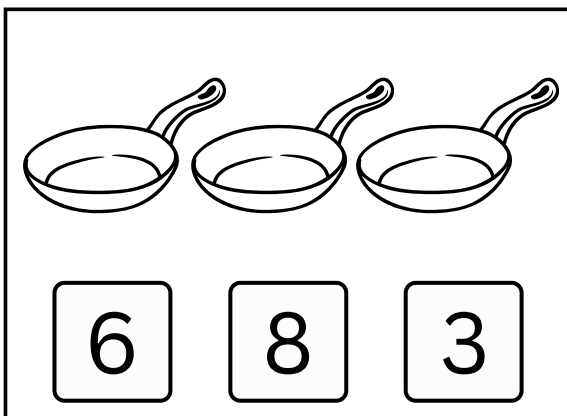
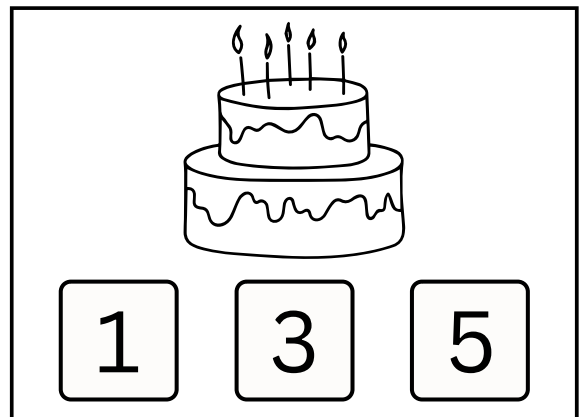
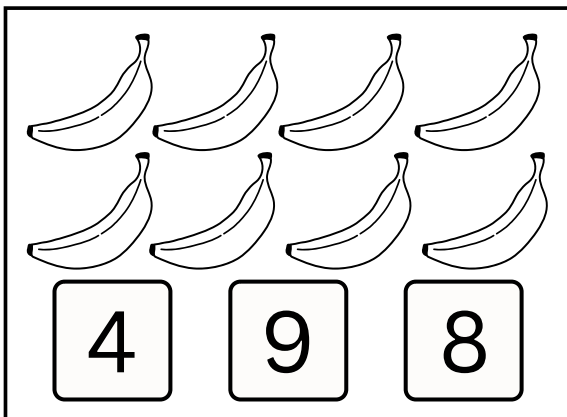
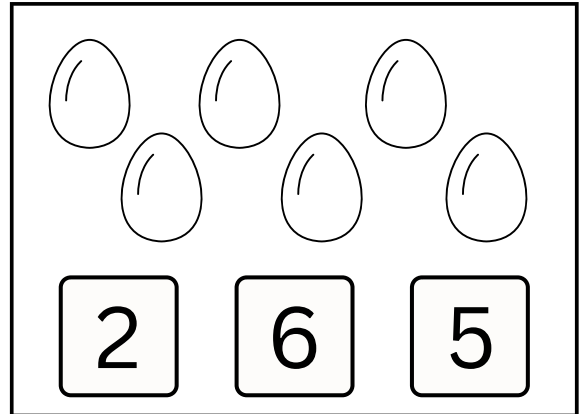
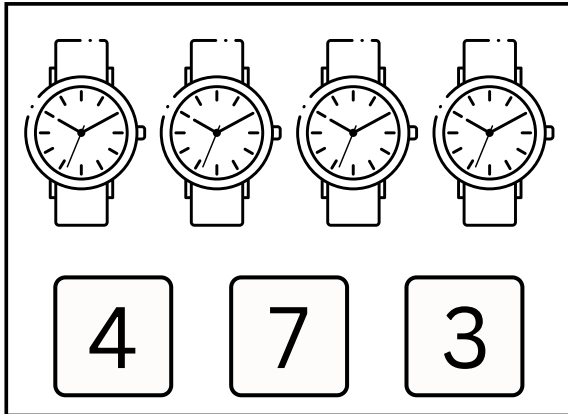

HOW MANY?

Name: _____

Date: _____

Instruction: Count the objects and colour the correct number.

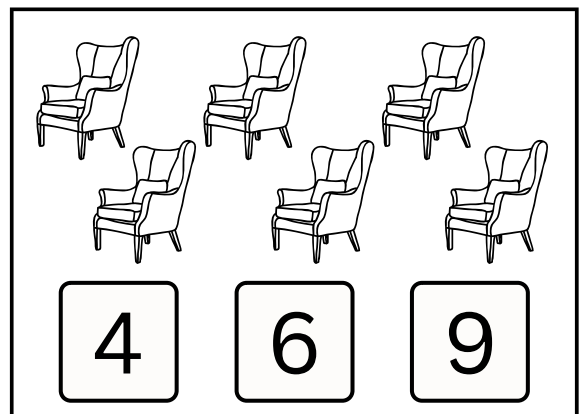
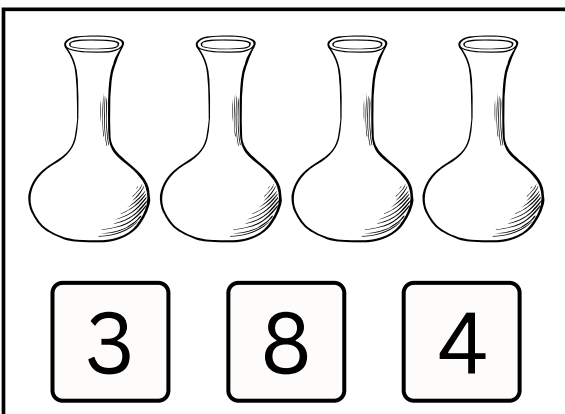
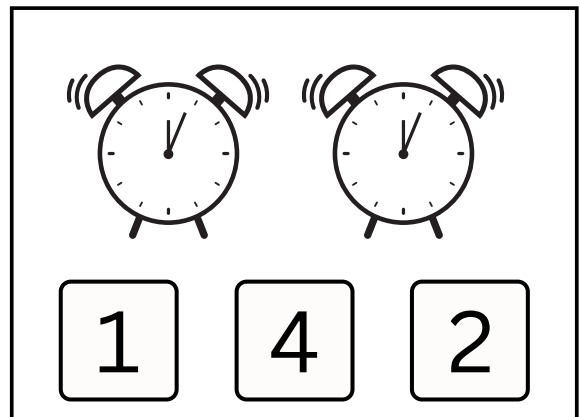
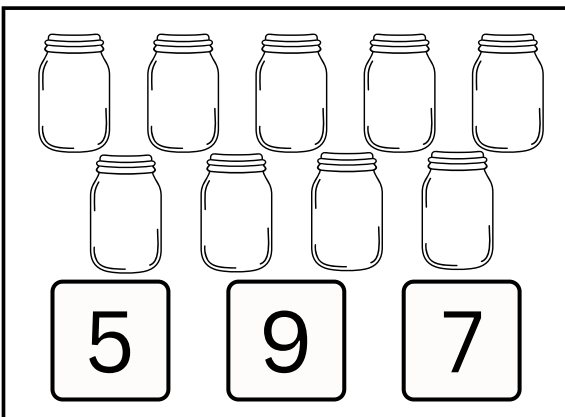
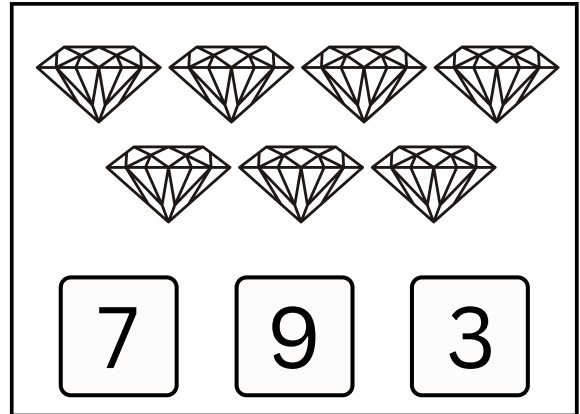
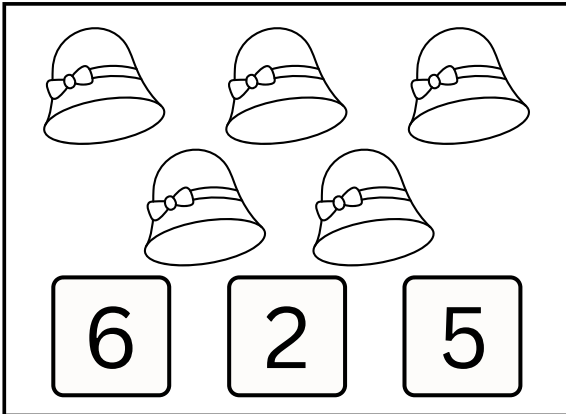

HOW MANY?

Name: _____

Date: _____

Instruction: Count the objects and colour the correct number.

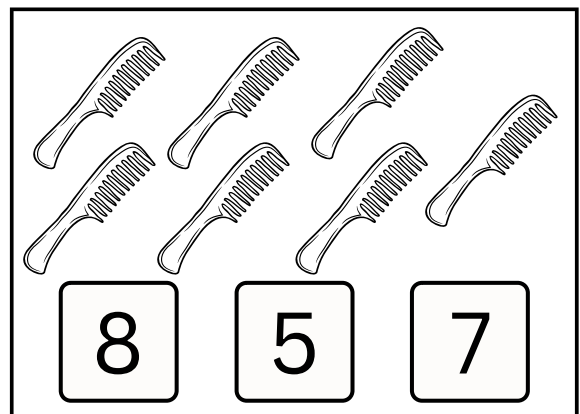
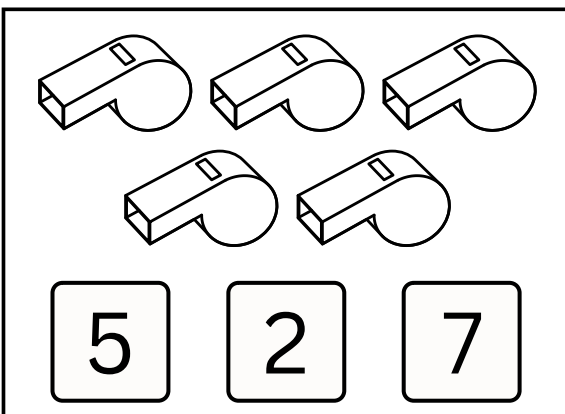
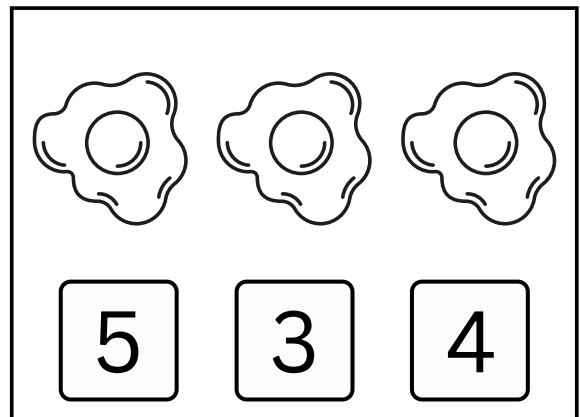
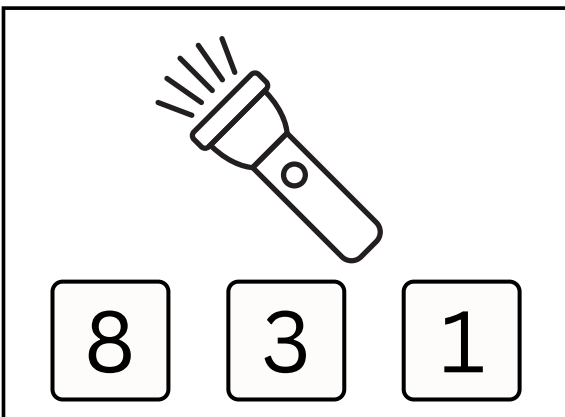
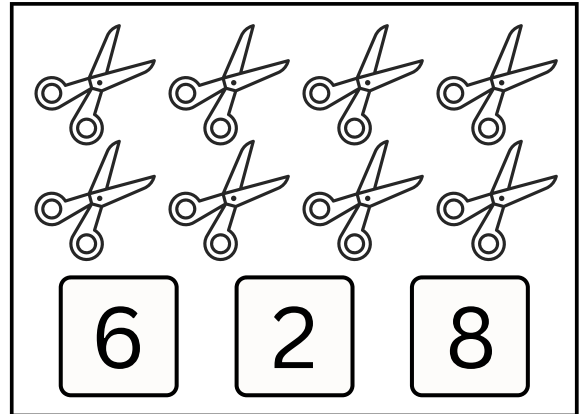
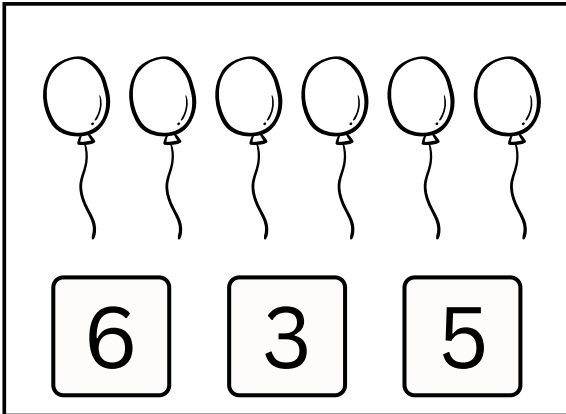

HOW MANY?

Name: _____

Date: _____

Instruction: Count the objects and colour the correct number.

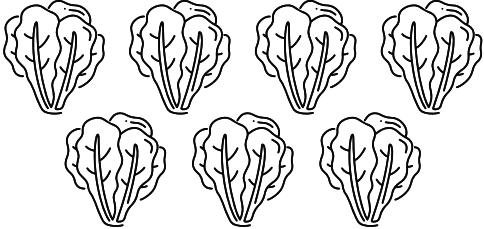

7 4 5

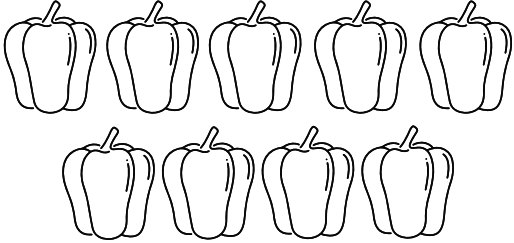

2 9 8

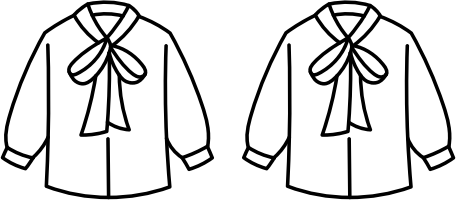

1 2 4



4 3 5

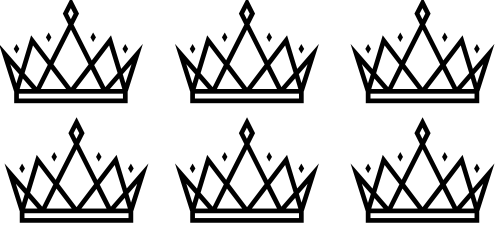

6 8 7

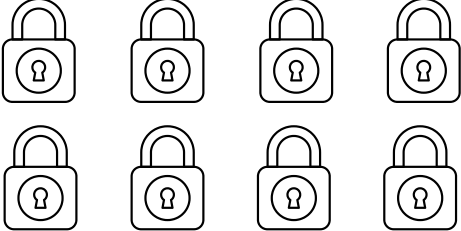

4 6 8

HOW MANY?

Name:

Date:

Instruction: Count the objects and colour the correct number.

