

Math Drill - Addition (1-10)

Name: _____

Date: _____

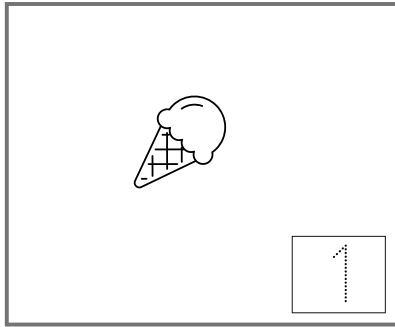

+

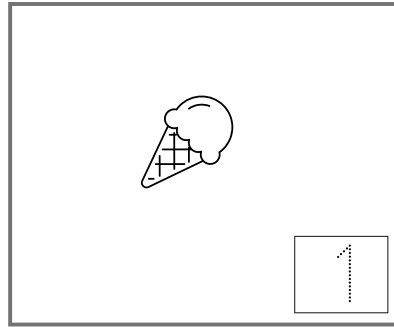

=

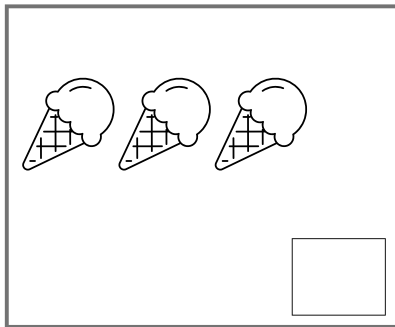

+

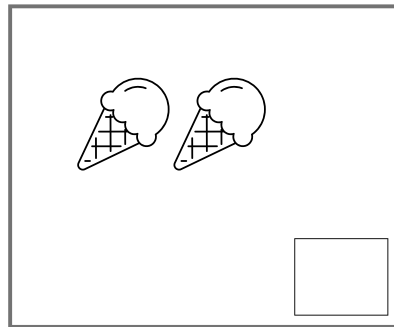

=

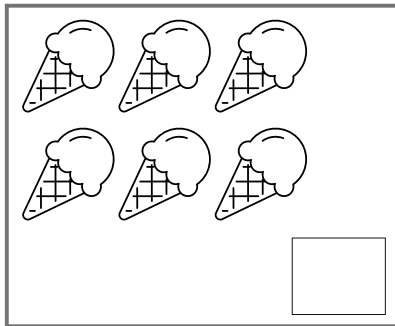

+

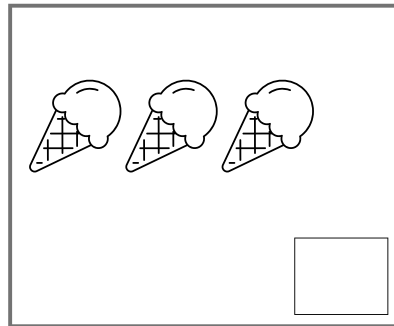

=

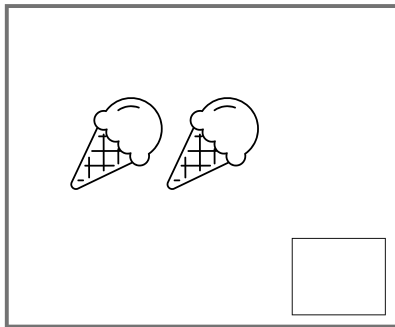

+

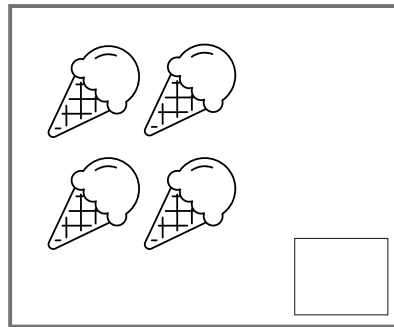

=

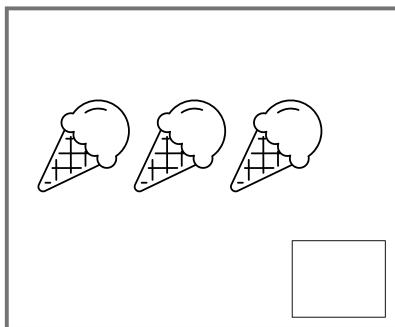

+

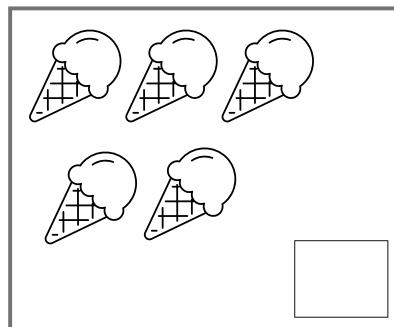

=



Math Drill - Addition (1-10)

Name: _____

Date: _____

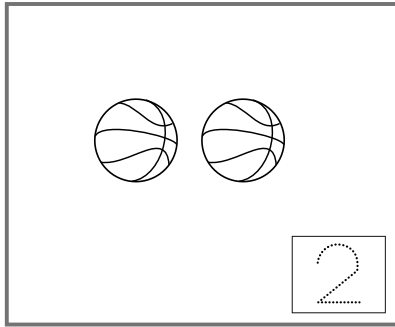

+

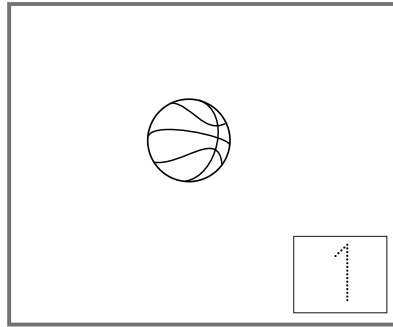

=

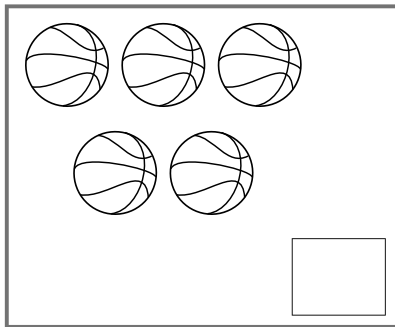

+

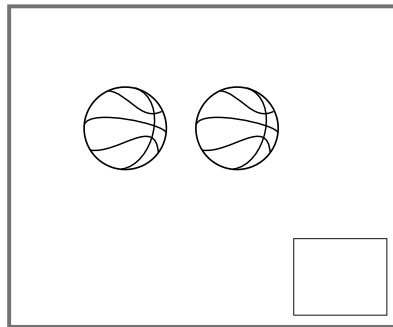

=

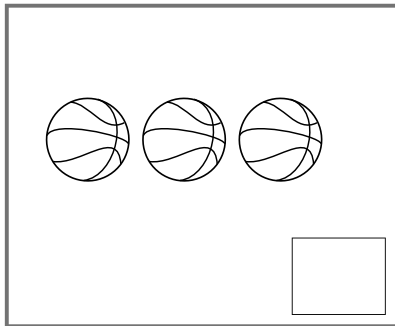

+

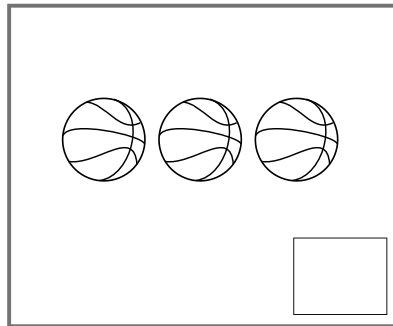

=

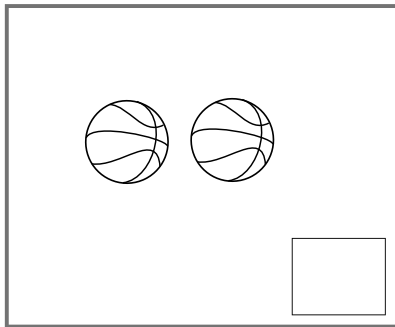

+

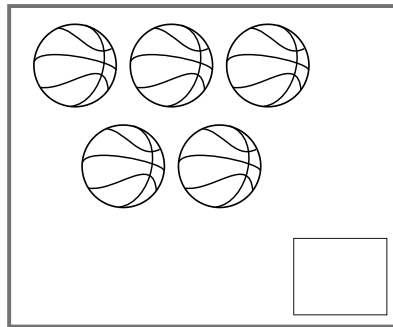

=

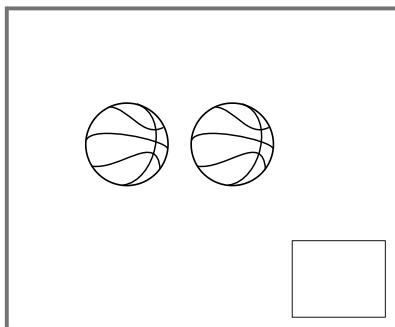

+

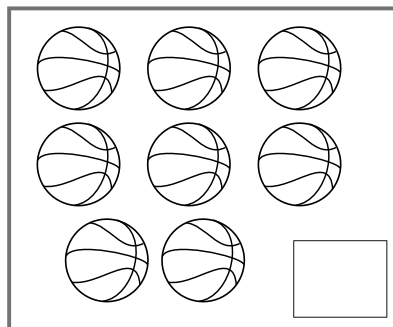

=



Math Drill - Addition (1-10)

Name: _____

Date: _____

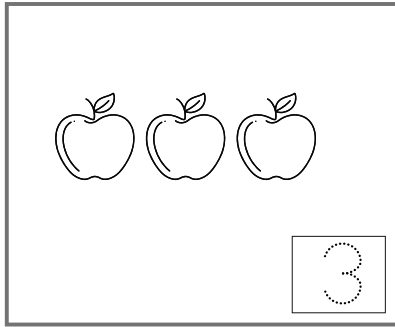

+

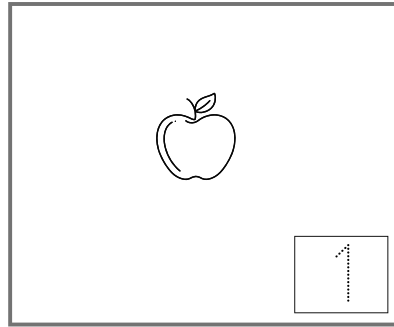

=

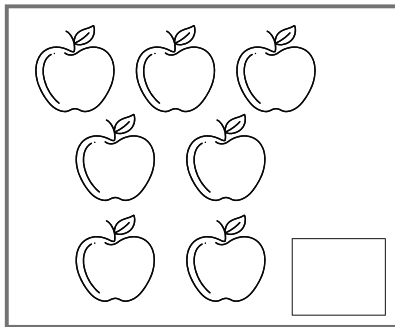
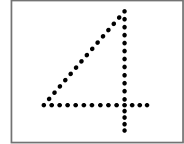

+

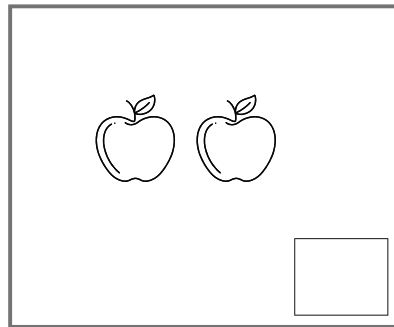

=

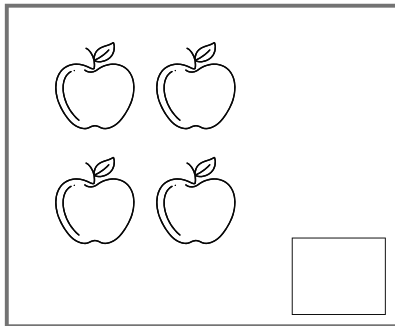

+

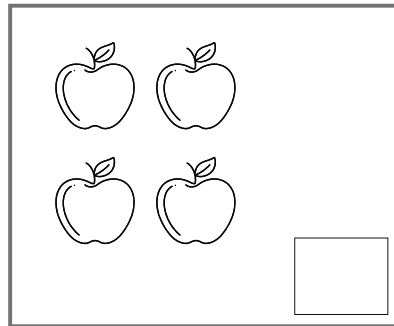

=

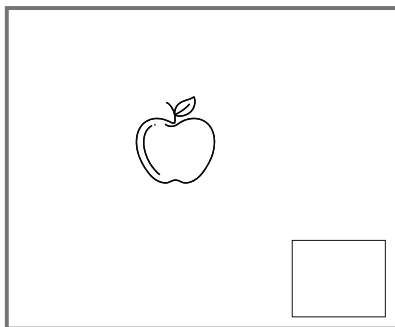

+

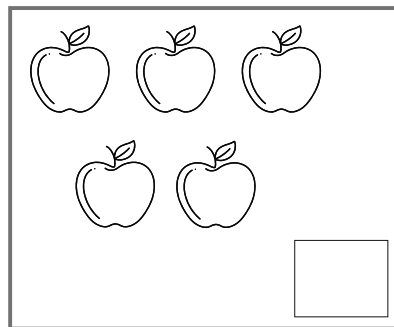

=

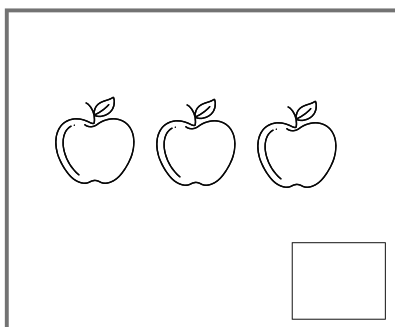

+

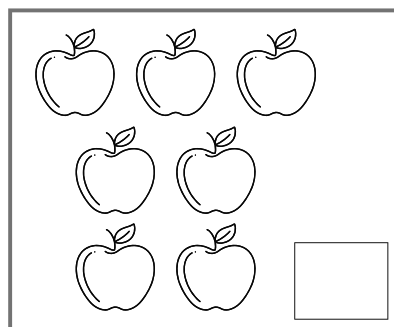

=



Math Drill - Addition (1-10)

Name: _____

Date: _____

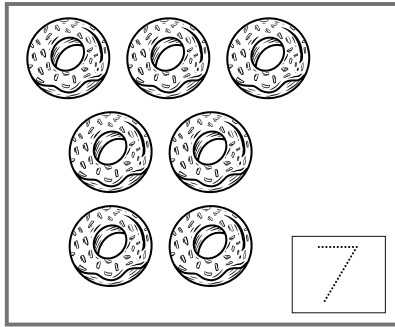

+

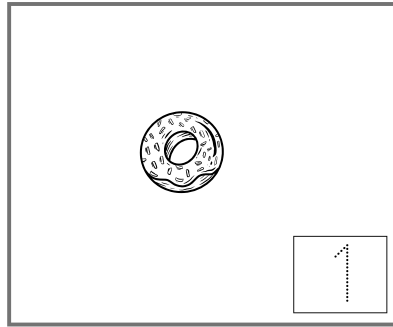

=

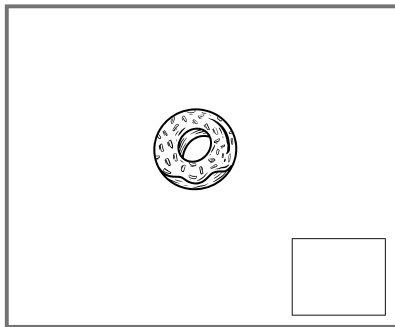
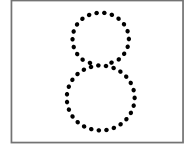

+

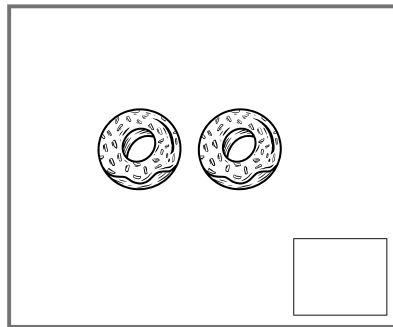

=

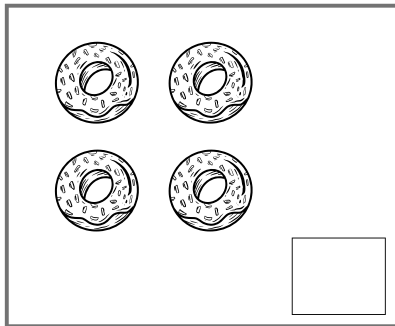
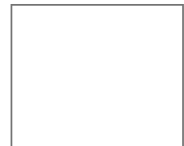

+

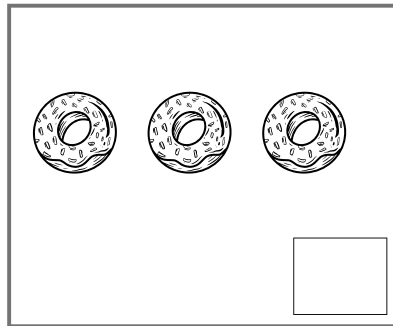

=

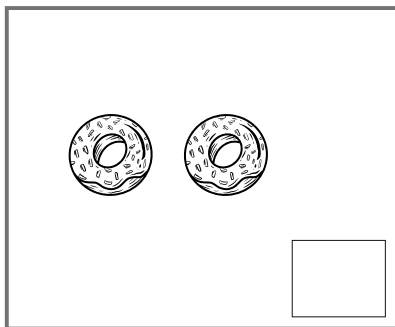

+

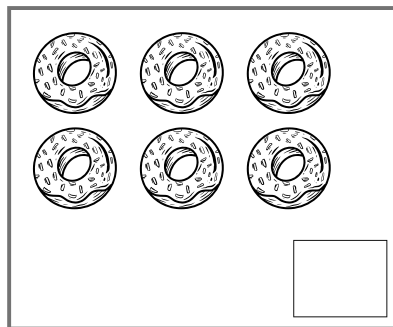

=

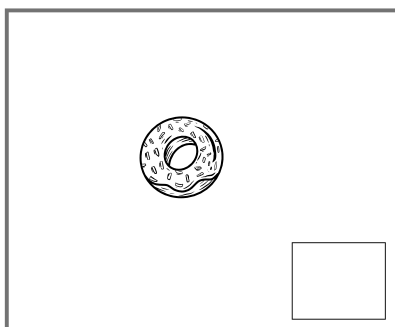
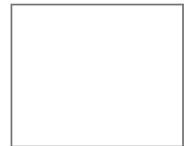

+

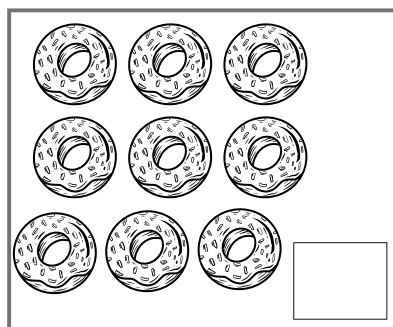

=



Math Drill - Addition (1-10)

Name: _____

Date: _____

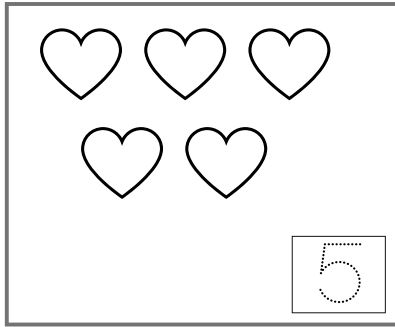

+

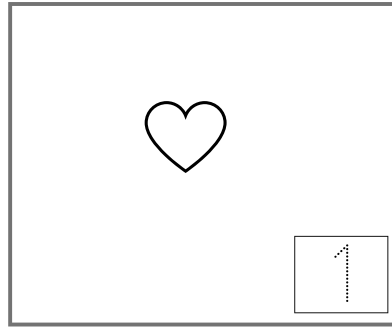

=

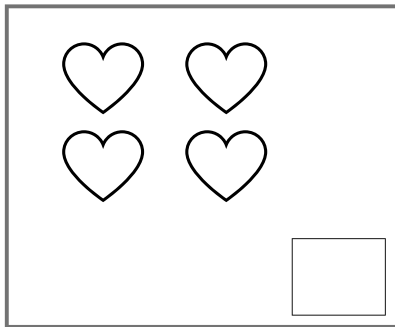
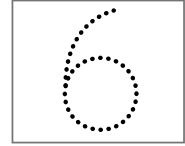

+

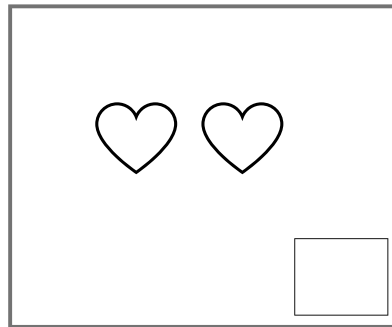

=

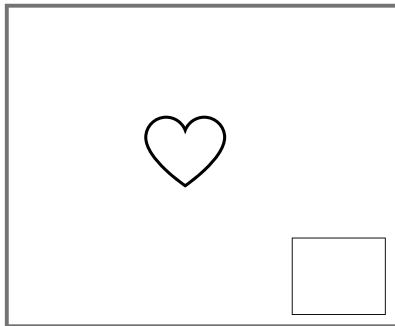

+

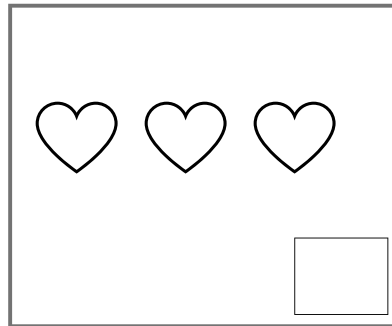

=

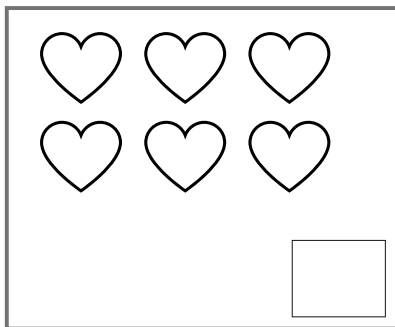

+

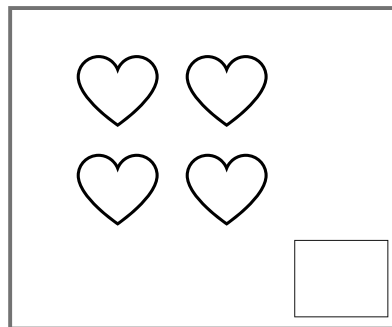

=

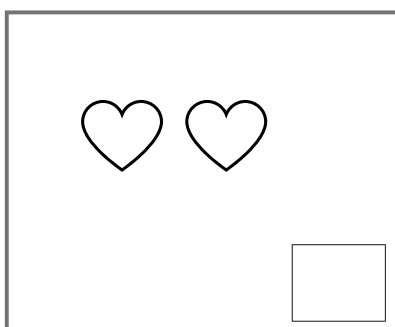

+

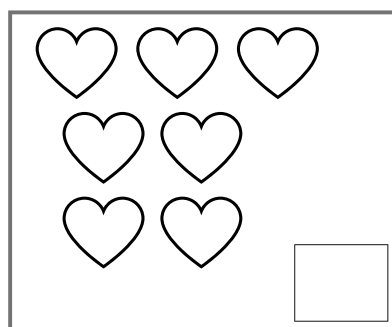

=



Math Drill - Addition (1-10)

Name: _____

Date: _____

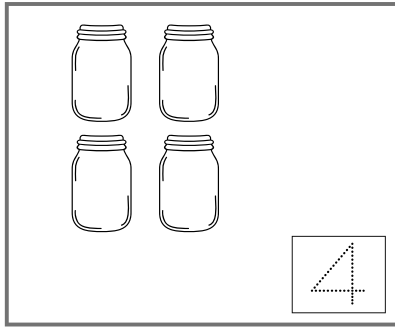

+

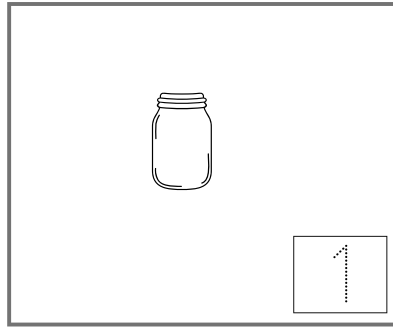

=

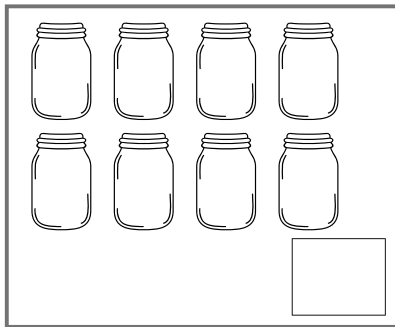

+

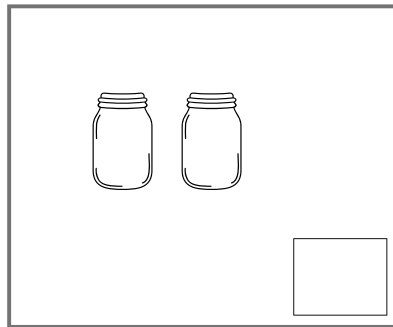

=

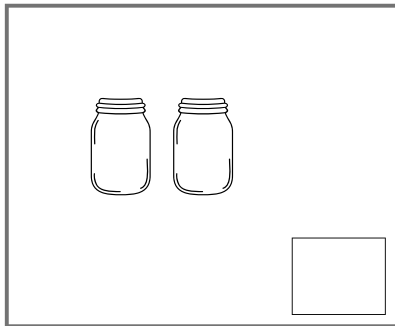

+

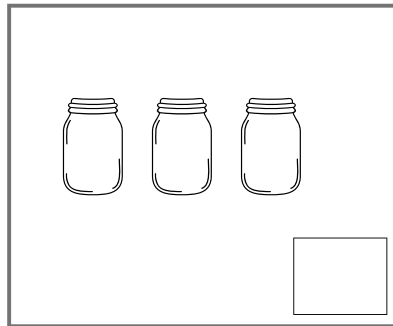

=

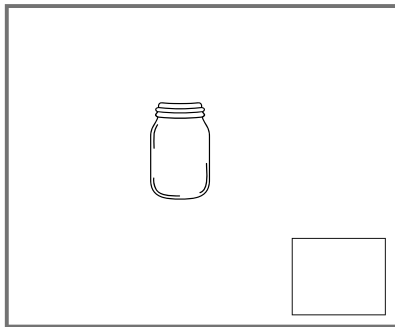

+

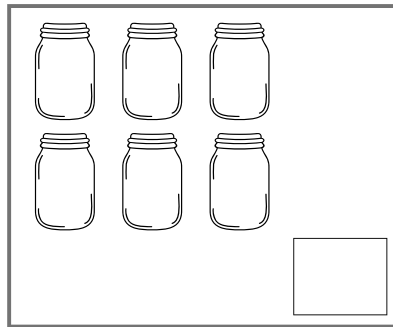

=

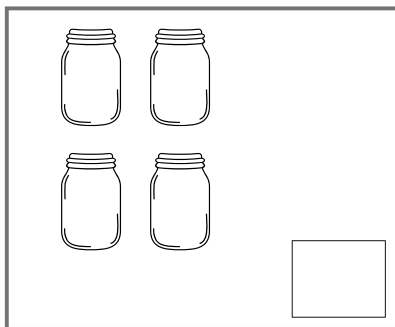

+

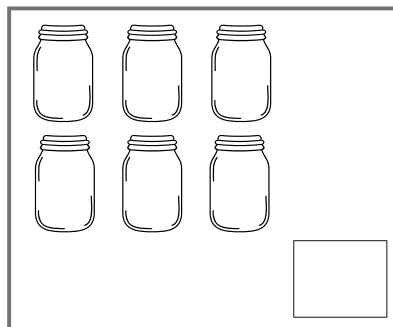

=



Math Drill - Addition (1-10)

Name: _____

Date: _____

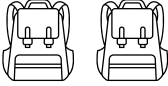

+

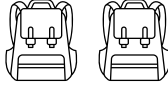

=

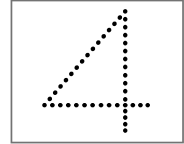

+

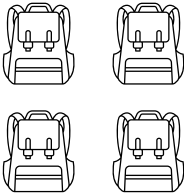

=

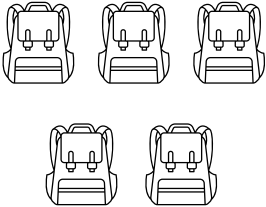
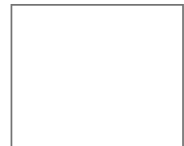

+

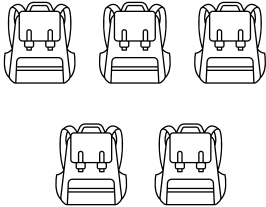

=

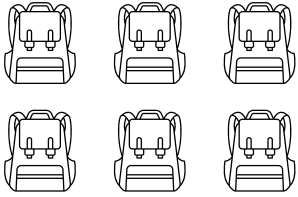

+



=



+

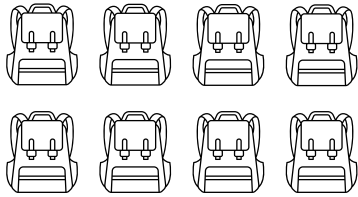

=



Math Drill - Addition (1-10)

Name: _____

Date: _____

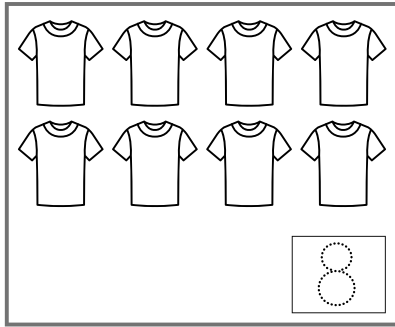

+

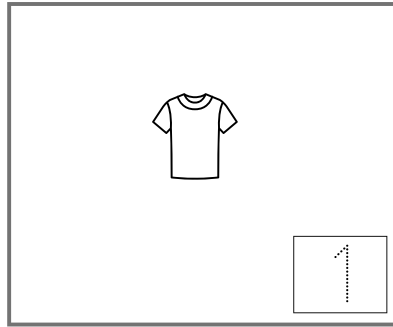

=

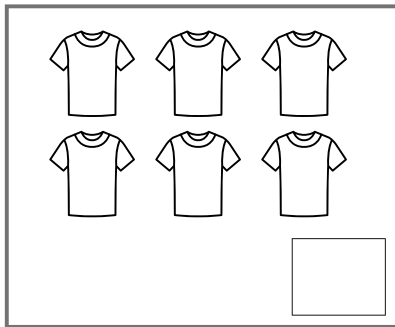
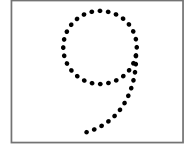

+

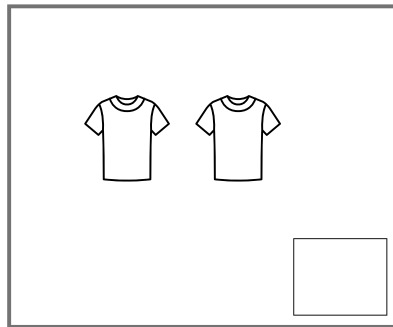

=

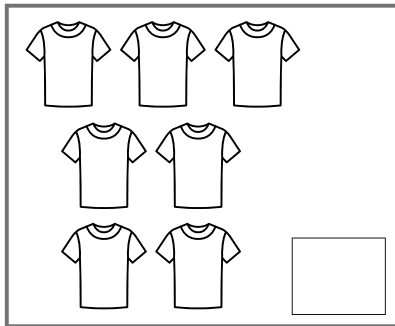

+

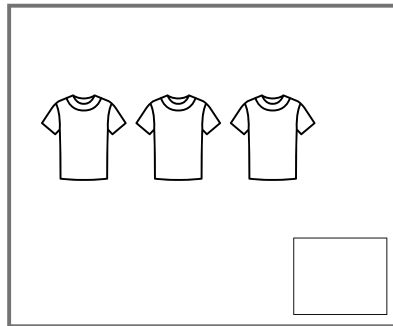

=

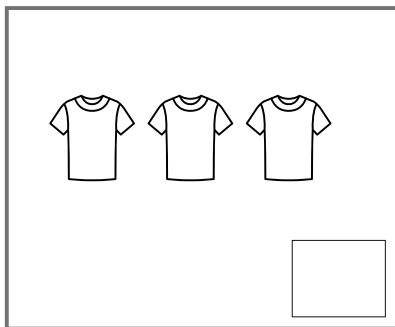

+

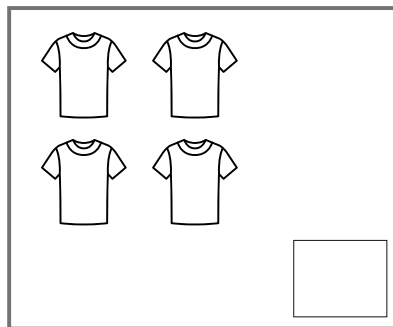

=

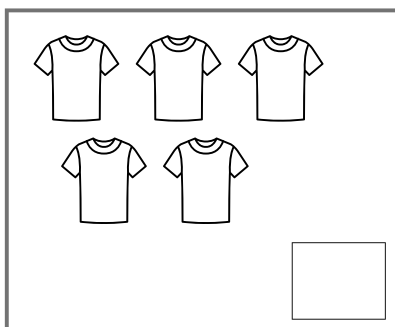

+

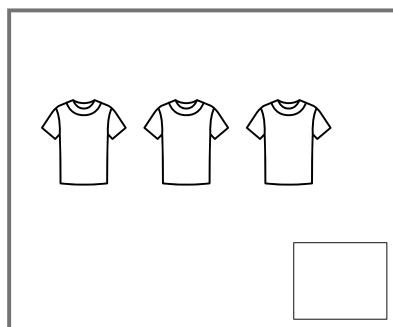

=



Math Drill - Addition (1-10)

Name: _____

Date: _____

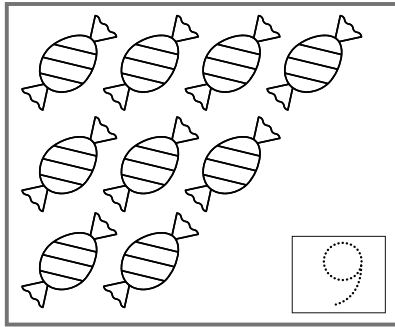

+

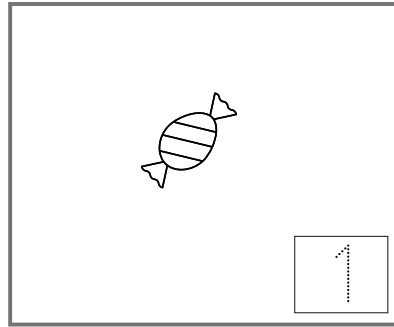

=

10

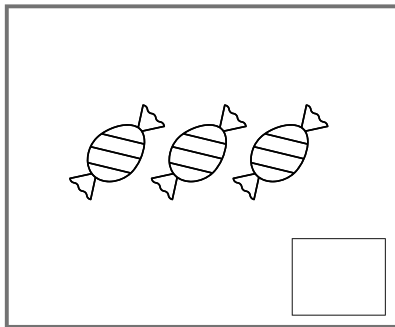

+

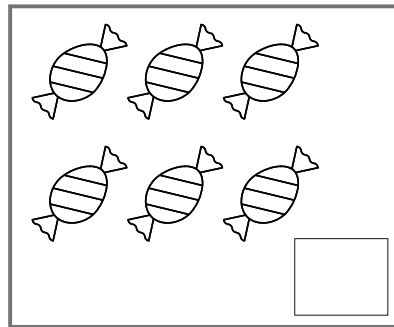

=

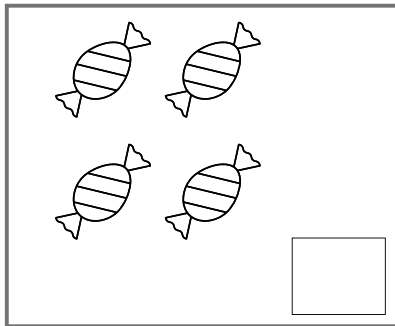

+

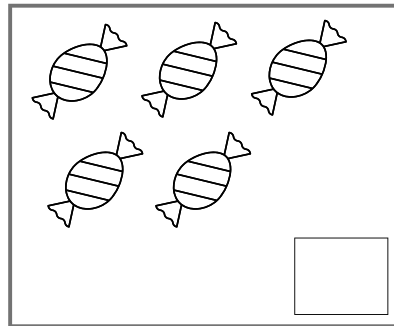

=

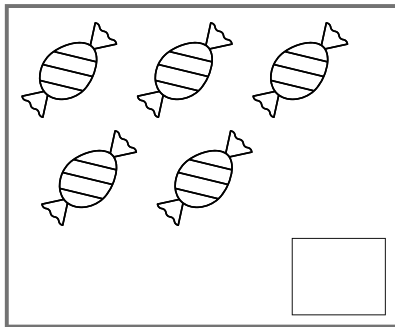

+

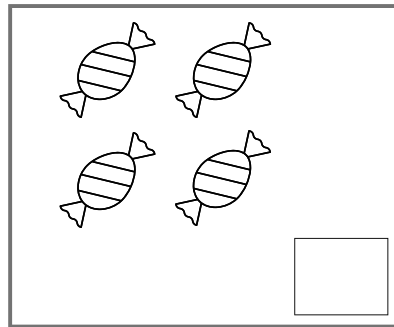

=

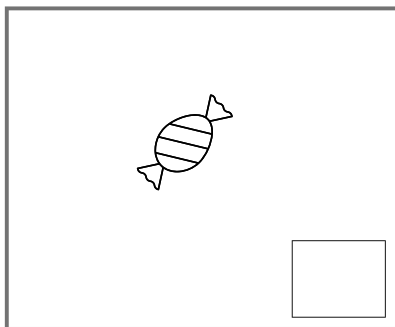

+

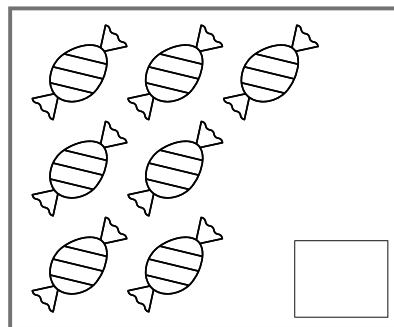

=